

LIVING

a flexible care concept by Smedbo®

 **SMEDBO**
Life in your bathroom



**10**
YEAR WARRANTY

LIVING



KOMFORT /
COMFORT



CHROMOBERFLÄCHE /
CHROME SURFACE



PARTS



100% ROSTFREI



GRIFFSICHERHEIT /
HANDLE SAFETY



FLEXIBLES SYSTEM /
FLEXIBLE SYSTEM



TRAGKRAFT 150 KG /
LOAD CAPACITY



VERTIKAL HORIZONTAL
45 GRAD /
VERTICAL HORIZONTAL
45 DEGREE



REINIGUNGSFREUNDLICH /
EASY TO CLEAN



DE

LIVING ist eine elegante Badserie mit Schwerpunkt Badsicherheit.

In Europa wächst der Bevölkerungsanteil mit älteren aktiven Menschen, die Wert auf Gesundheit, Design und Wohnkultur, verbunden mit Komfort und Bequemlichkeit legen. Unser Ziel bei der Entwicklung der neuen Bad Serie Living war es , mit dem Fokus auf Qualität und Funktionalität, genau diese Bedürfnisse zu erfüllen.

LIVING-Bad-Haltegriffe bestehen aus zwei Systemen. Es gibt einige Komplettssets, die zur einfachen Montage verwendet werden können. Zusätzlich gibt es planbare Einzelkomponenten, die individuell an die vorhandenen Raumsituationen angepasst werden können.

Die Komplettssets und planbaren Elemente können individuell kombiniert und an die persönlichen Bedürfnisse angepasst werden. Living bietet damit fast unbegrenzte Möglichkeiten, um passende Lösungen für nahezu jede Anforderung und das gewünschte Design im Badezimmer zu realisieren.

EN

LIVING - an elegant bathroom series focusing on bathroom safety and flexibility

In Europe we have a strongly growing population of people over 60 years. A highly active group with good health and a vast interest in home interior and design as well as a focus on quality, convenience and comfort. Our goal, when developing the new LIVING series, was to offer a range of bathroom safety items that answers to exactly those needs.

LIVING bathroom grab bars consists of two parts, first part are several standard modular systems that are ready to mount and use. The second part are independent parts that can be combined in an almost unlimited number of ways. The modular system and the independent items can be modified and combined into one and parts of the systems can be replaced with independent components to create solutions that suit the needs and appearance of the majority of bathrooms.



DE

Mit einem Sinn für Tradition, Qualität und Design

Seit über 50 Jahren gestalten und vertreiben wir bei Smedbo hochwertige Bad-Accessoires. Seit der Gründung 1967 ist es unser Ziel, dass Bad zum Wohlfühlen mit zeitgemäßem Design und Eleganz auszustatten. Bei Smedbo entwickeln wir seit Jahrzehnten Produkte mit einem klassisch, skandinavischen Design. Wir geben uns jedoch nicht damit zufrieden, dass ein Produkt nur schön oder elegant ist. Darüber hinaus muss es eine hohe Funktionalität bieten und den Bedürfnissen des Anwenders entsprechen. Unsere Produkte fügen sich ästhetisch und funktionell in Ihr Badezimmer ein.

Lange Lebensdauer und hohe Qualität sind zwei der wichtigsten Bestandteile bei der Konzeption und Entwicklung von unseren Programmen. Die meisten unserer Badserien sind aus massivem Messing gefertigt und werden anschließend mit einer speziellen Oberflächenbehandlung versehen. Diese Beschichtung garantiert Ihnen eine langjährige Nutzung und macht die Produkte noch widerstandsfähiger und pflegeleichter. Unser hoher Qualitätsanspruch, sowie eine sorgfältige Verarbeitung und der Einsatz bester Materialien, ermöglicht es uns auf alle Produkte eine Garantie von mindestens 5 oder 10 Jahre geben zu können.



EN

With a sense of tradition, quality and design

Smedbo has been designing and distributing high quality bathroom accessories for more than 50 years. Ever since 1967 and the launch of the Herrgård series, our goal has been to give the bathroom a sense of flair and elegance. We have for decades developed products with a strong classic, Scandinavian design as well as a strong function and focus on meet the needs of the user. A product that is both beautiful and functional will definitely deserve its place in the bathroom.

We focus on high quality which allows our products to be used regularly over a long period of time, therefore we are confident in offering guarantees of 5 to 10 years on all our products. We are also proud to be a selected Swedish Court Suppliers since many years.

LIVING | HALTEGRIFF- KOMPLETTSETS | GRAB BAR SOLUTIONS

Haltegriffe Komplettsets / Grab Bar Solutions ready to use



TRAGKRAFT 150 KG /
LOAD CAPACITY



FLEXIBLES
SYSTEM /
FLEXIBLE
SYSTEM



PARTS

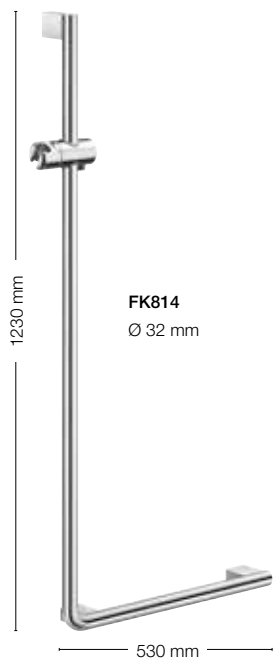

FK814
Ø 32 mm

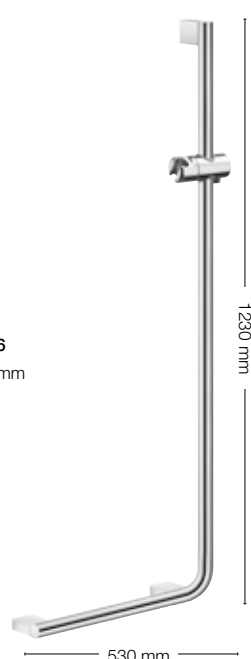

FK816
Ø 32 mm

FK810
Ø 32 mm

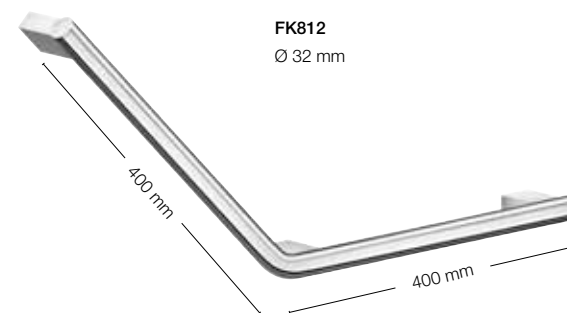
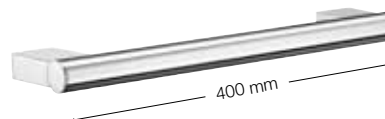

FK812
Ø 32 mm

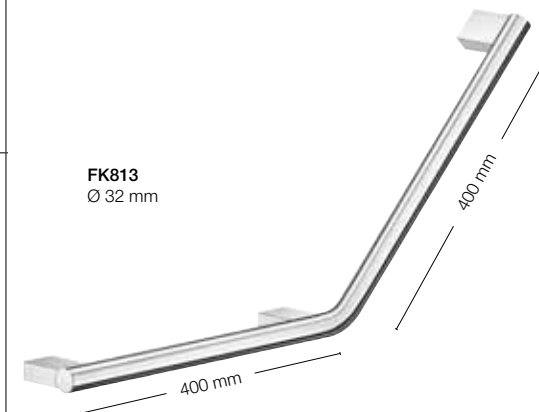

FK813
Ø 32 mm

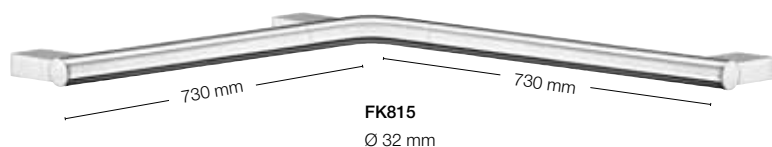

FK815
Ø 32 mm

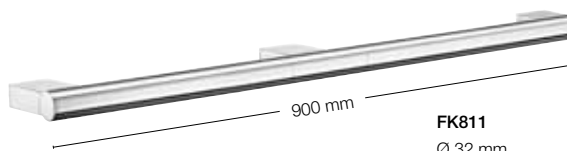

FK811
Ø 32 mm

FK810
Haltegriff
Single grab bar

FK811
Haltegriff
Double grab bar

FK812
V-förmiger Haltegriff, links
V-shaped grab bar, left

FK813
V-förmiger Haltegriff, rechts
V-shaped grab bar, right

FK814
Brausestange links- Verlängerung nach
rechts
L-shaped grab bar, right

FK815
Haltegriff 90 Grad Winkelset
Corner grab bar

FK816
Brausestange rechts- Verlängerung nach
links
L-shaped grab bar, left

LIVING | INDIVIDUELL PLANBARE EINZELTEILE | GRAB BAR PARTS

Haltegriffe Ergänzungsteile zur individuellen Planung / Grab Bar Parts to design your custom made solution



TRAGKRAFT 150 KG /
LOAD CAPACITY



FLEXIBLES
SYSTEM /
FLEXIBLE
SYSTEM



PARTS

FK830
Ø 32 mm

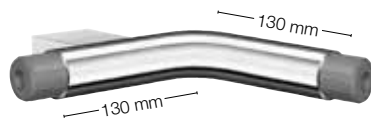
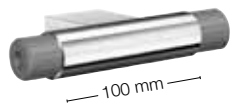

FK832
Ø 32 mm

FK820
Ø 32 mm

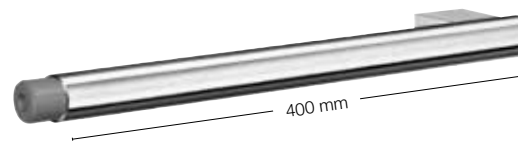

FK831
Ø 32 mm

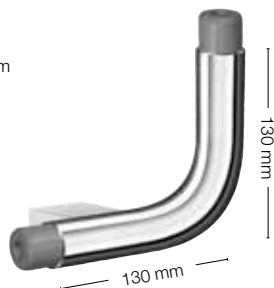

FK833
Ø 32 mm

FK835
Ø 32 mm

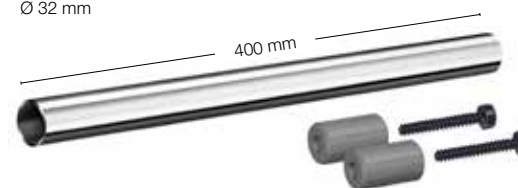

FK821
Ø 32 mm

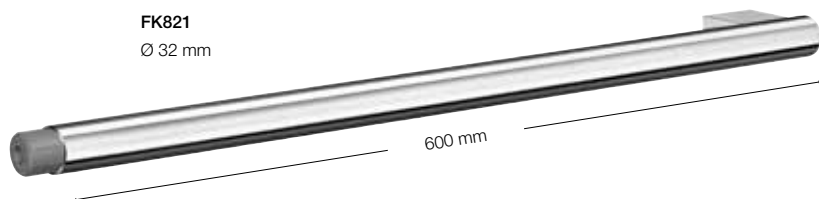

FK820
Haltegriff - Verlängerung 40 cm
Fixing point

FK821
Haltegriff - Verlängerung 60 cm
Fixing point

FK830
T-Anschlussstück
Connection T-shape

FK831
Verbindungselement L-Form,
Verlängerung nach links
Connection L-shape

FK832
Eckverbindung 90 grad
Corner connection

FK833
Verbindungselement L-Form,
Verlängerung nach rechts
Connection L-shape

FK835
Erweiterungselement
Connection bar





TRAGKRAFT 150 KG /
LOAD CAPACITY



FLEXIBLES
SYSTEM /
FLEXIBLE
SYSTEM



PARTS

MODIFIED SOLUTIONS

DE

Kombinieren Sie Ihre Produkte zu einem Endprodukt komplett auf Ihre Bedürfnisse abgestimmt.

UK

Combine your products into solutions completely adapted to your needs.

FK811 + FK821

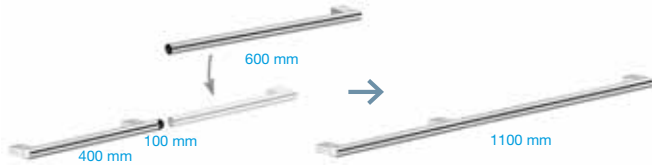

FK815 + FK821



FK814/FK816 + FK821

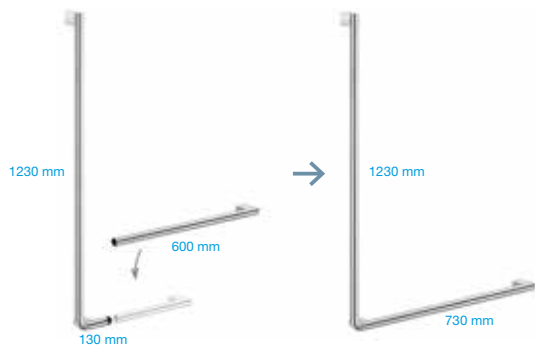

FK814/FK816 + FK835 + FK815

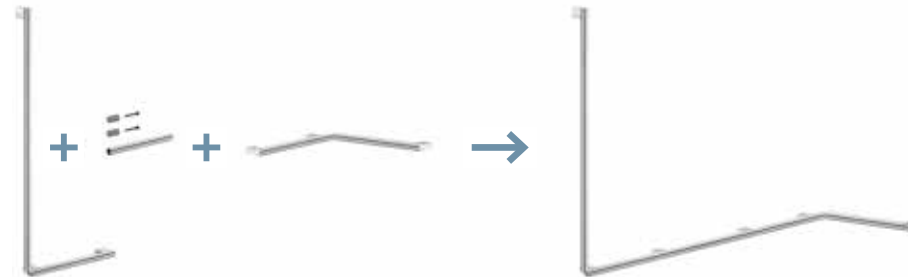

FK815 + FK820



FK814 + FK820

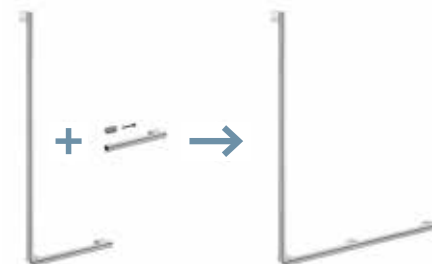

FK814/FK816 + FK835 + FK815

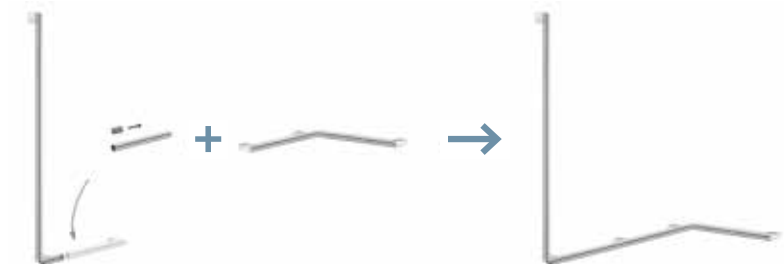

LIVING | EXAMPLES





LIVING | LIVING SPEZIAL PRODUKTE | BATHROOM ACCESSORIES



KOMFORT /
COMFORT



TRAGKRAFT 150 KG /
LOAD CAPACITY

FK840

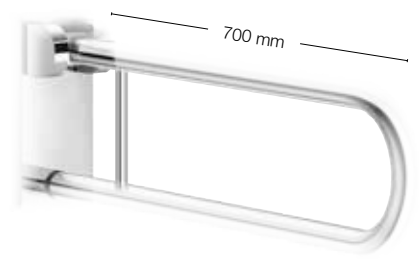

FK841

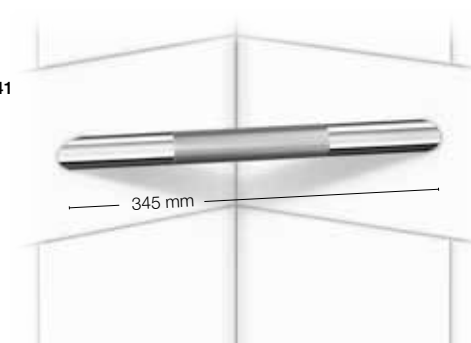

FK840
Stütz-Klappgriff
Hinged grab bar

Max 150 kg

FK841
Fußstütze-Eckversion
Footrest, corner

Max 150 kg



LIVING | STANDARD HALTEGRIFFE | BASIC GRAB BARS



KOMFORT /
COMFORT



TRAGKRAFT 150 KG /
LOAD CAPACITY

FK806

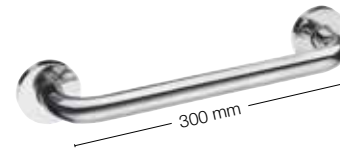

FK807

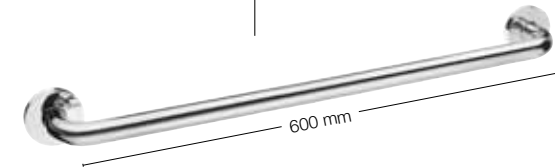

FK808

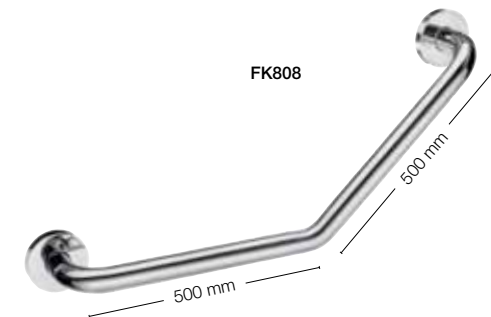

FK806

Wannengriff kurze gebogene Version
Grab bar curved short

Max 150 kg

FK807

Wannengriff lange gebogene Version
Grab bar curved long

Max 150 kg

FK808

Wannengriff lange gebogene Version v-form/ 135°
Grab bar curved long v-form 135°

Max 150 kg

Hinweis

Haltegriffe auf dieser Seite sind aus der Basic Serie und nicht veränderbar.

Note

Grab bars on this page are the Smedbo Basic range and can not be modified.

OUTLINE | DUSCH KLAPPSITZ | BATHROOM PALLETS



KOMFORT /
COMFORT



TRAGKRAFT 150 KG /
LOAD CAPACITY



FK404



FK414

FK404
Duschklappsitz wandmontiert, weiß
Folding wall mounted shower seat, white

Max 150 kg

FK414
Duschklappsitz wandmontiert, grau
Folding wall mounted shower seat, grey

Max 150 kg





**OUTLINE | DUSCHHOCKER |
BATHROOM PALLETS**



KOMFORT /
COMFORT



TRAGKRAFT 150 KG /
LOAD CAPACITY

FK406



FK416



FK406
Duschhocker
Shower stool, white polypropylene
Max 150 kg

FK416
Duschhocker
Shower stool, black polypropylene
Max 150 kg

FK401
Duschhocker
Shower stool, white werzalit
Max 150 kg

FK411
Duschhocker
Shower stool, black werzalit
Max 150 kg



 **SMEDBO**
Life in your bathroom

SMEDBO GMBH
AN DER STRUSBEEK 68, D-22926 AHRENSBURG
www.smedbo.de



LIVING